

## MPSA06

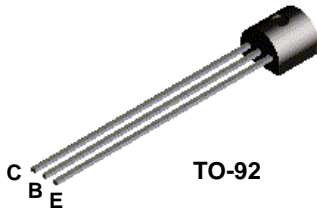

## MMBTA06

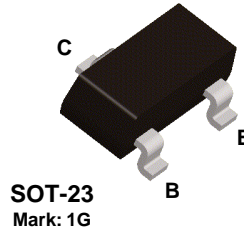

## PZTA06

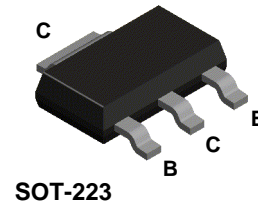

## NPN General Purpose Amplifier

This device is designed for general purpose amplifier applications at collector currents to 300 mA. Sourced from Process 33.

### Absolute Maximum Ratings\*

TA = 25°C unless otherwise noted

Symbol	Parameter	Value	Units
V <sub>CEO</sub>	Collector-Emitter Voltage	80	V
V <sub>CBO</sub>	Collector-Base Voltage	80	V
V <sub>EBO</sub>	Emitter-Base Voltage	4.0	V
I <sub>C</sub>	Collector Current - Continuous	500	mA
T <sub>J</sub> , T <sub>stg</sub>	Operating and Storage Junction Temperature Range	-55 to +150	°C

\*These ratings are limiting values above which the serviceability of any semiconductor device may be impaired.

#### NOTES:

- 1) These ratings are based on a maximum junction temperature of 150 degrees C.
- 2) These are steady state limits. The factory should be consulted on applications involving pulsed or low duty cycle operations.

### Thermal Characteristics

TA = 25°C unless otherwise noted

Symbol	Characteristic	Max			Units
		MPSA06	*MMBTA06	**PZTA06	
P <sub>D</sub>	Total Device Dissipation	625	350	1,000	mW
	Derate above 25°C	5.0	2.8	8.0	mW/°C
R <sub>θJC</sub>	Thermal Resistance, Junction to Case	83.3			°C/W
R <sub>θJA</sub>	Thermal Resistance, Junction to Ambient	200	357	125	°C/W

\* Device mounted on FR-4 PCB 1.6" X 1.6" X 0.06."

\*\* Device mounted on FR-4 PCB 36 mm X 18 mm X 1.5 mm; mounting pad for the collector lead min. 6 cm<sup>2</sup>.

# NPN General Purpose Amplifier

(continued)

## Electrical Characteristics

TA = 25°C unless otherwise noted

Symbol	Parameter	Test Conditions	Min	Max	Units
<b>OFF CHARACTERISTICS</b>					
$V_{(BR)CEO}$	Collector-Emitter Sustaining Voltage*	$I_C = 1.0 \text{ mA}, I_B = 0$	80		V
$V_{(BR)EBO}$	Emitter-Base Breakdown Voltage	$I_E = 100 \text{ } \mu\text{A}, I_C = 0$	4.0		V
$I_{CEO}$	Collector-Cutoff Current	$V_{CE} = 60 \text{ V}, I_B = 0$		0.1	$\mu\text{A}$
$I_{CBO}$	Collector-Cutoff Current	$V_{CB} = 80 \text{ V}, I_E = 0$		0.1	$\mu\text{A}$

## ON CHARACTERISTICS

$h_{FE}$	DC Current Gain	$I_C = 10 \text{ mA}, V_{CE} = 1.0 \text{ V}$ $I_C = 100 \text{ mA}, V_{CE} = 1.0 \text{ V}$	100 100		
$V_{CE(sat)}$	Collector-Emitter Saturation Voltage	$I_C = 100 \text{ mA}, I_B = 10 \text{ mA}$		0.25	V
$V_{BE(on)}$	Base-Emitter On Voltage	$I_C = 100 \text{ mA}, V_{CE} = 1.0 \text{ V}$		1.2	V

## SMALL SIGNAL CHARACTERISTICS

$f_T$	Current Gain - Bandwidth Product	$I_C = 10 \text{ mA}, V_{CE} = 2.0 \text{ V},$ $f = 100 \text{ MHz}$	100		MHz
-------	----------------------------------	---	-----	--	-----

\*Pulse Test: Pulse Width  $\leq 300 \text{ } \mu\text{s}$ , Duty Cycle  $\leq 2.0\%$

## Spice Model

NPN (Is=8.324f Xti=3 Eg=1.11 Vaf=100 Bf=12.16K Ne=1.368 Ise=73.27f Ikf=.1096 Xtb=1.5 Br=11.1 Nc=2 Isc=0 Ikr=0 Rc=.25 Cjc=18.36p Mjc=.3843 Vjc=.75 Fc=.5 Cje=55.61p Mje=.3834 Vje=.75 Tr=72.15n Tf=516.1p Itf=.5 Vtf=4 Xtf=6 Rb=10)

## Typical Characteristics

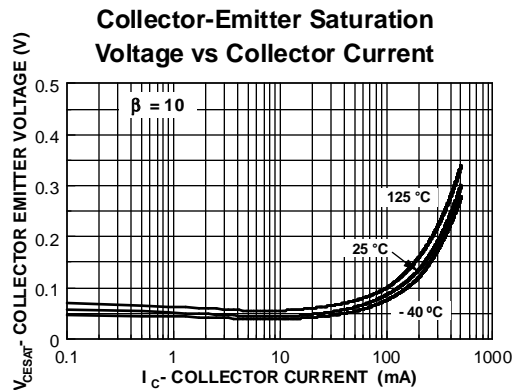
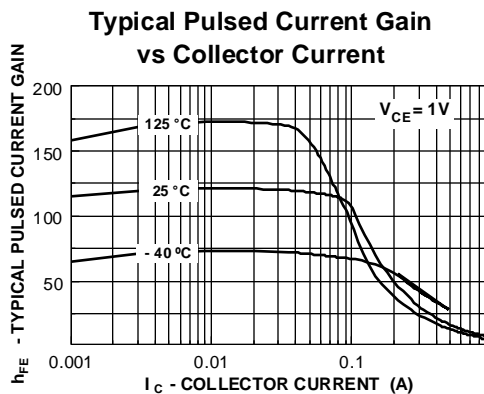

Typical Characteristics (continued)

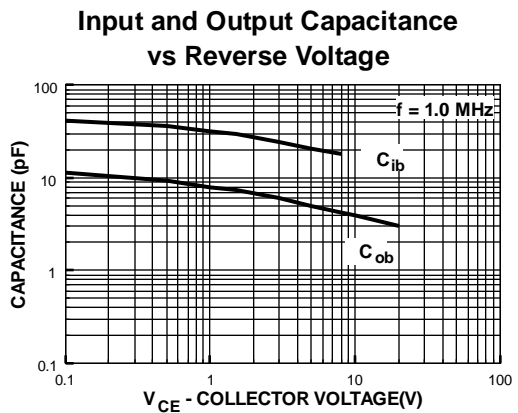
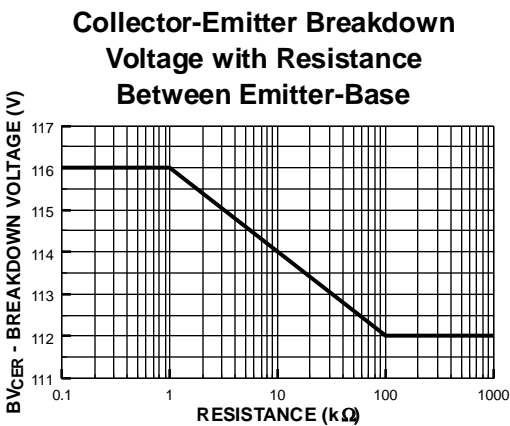
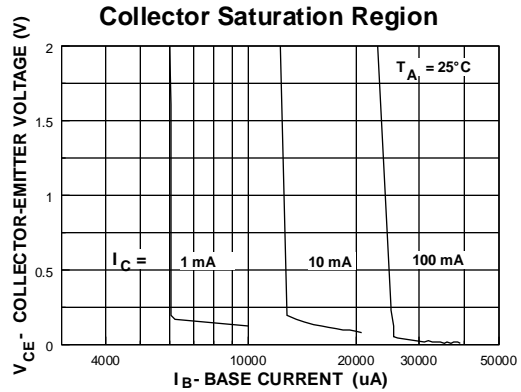
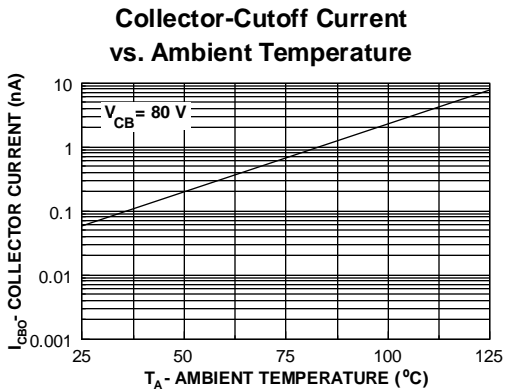
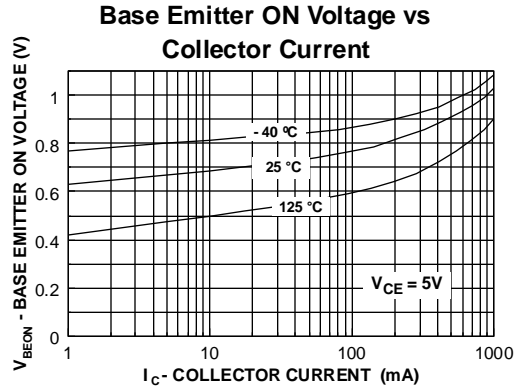
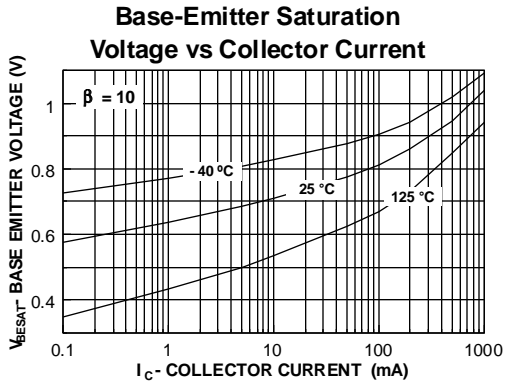

# NPN General Purpose Amplifier

(continued)

MPSA06 / NMBTA06 / PZTA06

## Typical Characteristics (continued)

### Gain Bandwidth Product vs Collector Current

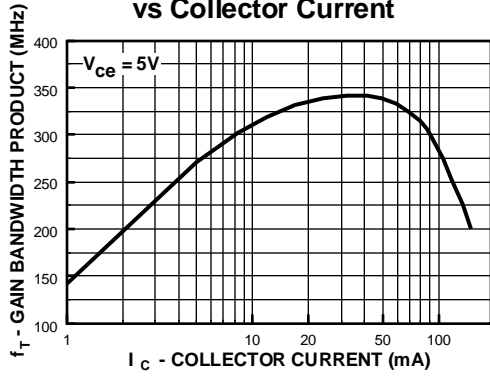

### Power Dissipation vs Ambient Temperature

